



GCSE PHYSICS

H

Higher Tier

Paper 1H

Specimen 2018

Time allowed: 1 hour 45 minutes

Materials

For this paper you must have:

- a ruler
- a calculator
- the Physics Equation Sheet (enclosed).

Instructions

- Answer **all** questions in the spaces provided.
- Do all rough work in this book. Cross through any work you do not want to be marked.

Information

- There are 100 marks available on this paper.
- The marks for questions are shown in brackets.
- You are expected to use a calculator where appropriate.
- You are reminded of the need for good English and clear presentation in your answers.
- When answering questions 02, 12 and 13.4 you need to make sure that your answer:
 - is clear, logical, sensibly structured
 - fully meets the requirements of the question
 - shows that each separate point or step supports the overall answer.

Advice

- In all calculations, show clearly how you work out your answer.

Please write clearly, in block capitals.

Centre number

Candidate number

Surname

Forename(s)

Candidate signature _____

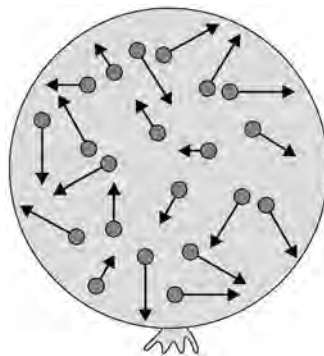
0 1**Figure 1** shows a balloon filled with helium gas.**Figure 1****0 1** . **1**

Describe the movement of the particles of helium gas inside the balloon.

[2 marks]

0 1 . **2**

What name is given to the total kinetic energy and potential energy of all the particles of helium gas in the balloon?

[1 mark]Tick **one** box.External energy Internal energy Movement energy

0 1 . **3** Write down the equation which links density, mass and volume.

[1 mark]

0 1 . **4** The helium in the balloon has a mass of 0.00254 kg.

The balloon has a volume of 0.0141 m³.

Calculate the density of helium. Choose the correct unit from the box.

[3 marks]

m^3 / kg	kg / m^3	kg m^3
--------------------------	--------------------------	-----------------

Density = _____ Unit: _____

Turn over for the next question

There are no questions printed on this page

0 2

Scientists sometimes replace one scientific model with a different model.

For example in the early 20th Century the plum pudding model of the atom was replaced by the nuclear model of the atom.

Explain what led to the plum pudding model of the atom being replaced by the nuclear model of the atom.

[6 marks]

Turn over for the next question

0 3

The National Grid ensures that the supply of electricity always meets the demand of the consumers.

Figure 2 shows how the output from fossil fuel power stations in the UK varied over a 24-hour period.

Figure 2

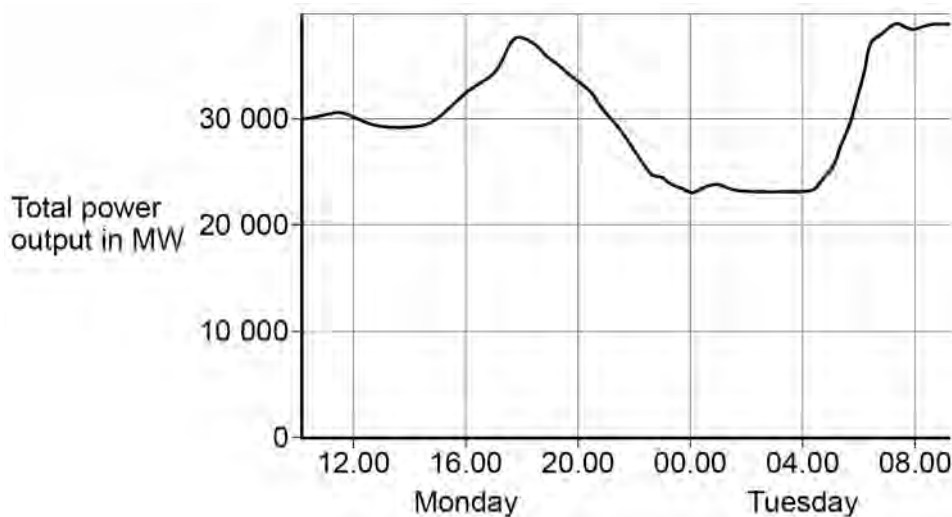
**0 3****1**

Suggest **one** reason for the shape of the graph between 15.00 and 18.00 on Monday.

[1 mark]

0 3**2**

Gas fired power stations reduce their output when demand for electricity is low.

Suggest **one** time on **Figure 2** when the demand for electricity was low.

[1 mark]

0 3 . **3** The National Grid ensures that fossil fuel power stations in the UK only produce about 33% of the total electricity they could produce when operating at a maximum output.

Suggest **two** reasons why.

[2 marks]

1

2

Turn over for the next question

0 4

A student investigated how much energy from the Sun was incident on the Earth's surface at her location.

She put an insulated pan of water in direct sunlight and measured the time it took for the temperature of the water to increase by $0.6\text{ }^{\circ}\text{C}$.

The apparatus she used is shown in **Figure 3**.

Figure 3

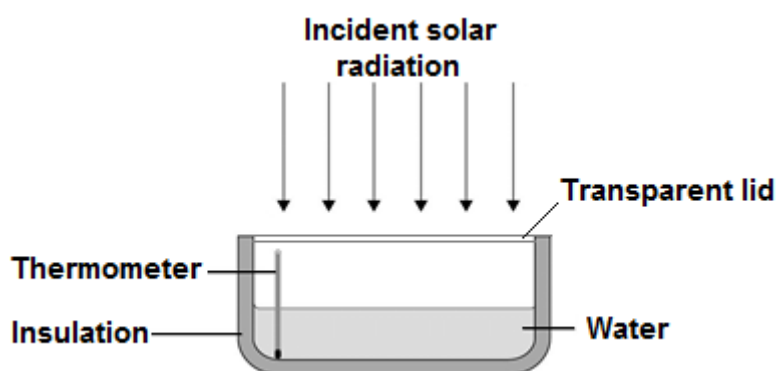
**0 4****. 1**

Choose the most appropriate resolution for the thermometer used by the student.

[1 mark]

Tick **one** box.

0.1 $^{\circ}\text{C}$

0.5 $^{\circ}\text{C}$

1.0 $^{\circ}\text{C}$

The energy transferred to the water was 1050 J.

The time taken for the water temperature to increase by 0.6 °C was 5 minutes.

The specific heat capacity of water is 4200 J/kg °C.

0 4 . **2** Write down the equation which links energy transferred, power and time.

[1 mark]

0 4 . **3** Calculate the mean power supplied by the Sun to the water in the pan.

[2 marks]

Average power = _____ W

0 4 . **4** Calculate the mass of water the student used in her investigation.

Use the correct equation from the Physics Equation Sheet.

[3 marks]

Mass = _____ kg

0 4 . **5** The student's results can only be used as an estimate of the mean power at her location.

Give **one** reason why.

[1 mark]

0 5

A student investigated the efficiency of a motor using the equipment in **Figure 4**.

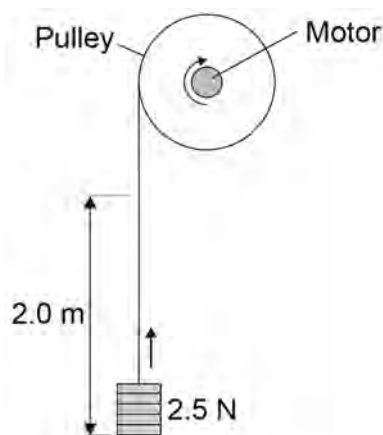
Figure 4

He used the motor to lift a weight of 2.5 N a height of 2.0 m.

He measured the speed at which the weight was lifted and calculated the efficiency of the energy transfer.

He repeated the experiment to gain two sets of data.

0 5**1**

Give **one** variable that the student controlled in his investigation.

[1 mark]

0 5**2**

Give **two** reasons for taking repeat readings in an investigation.

[2 marks]

1 _____

2 _____

Figure 5 shows a graph of the student's results.

Figure 5

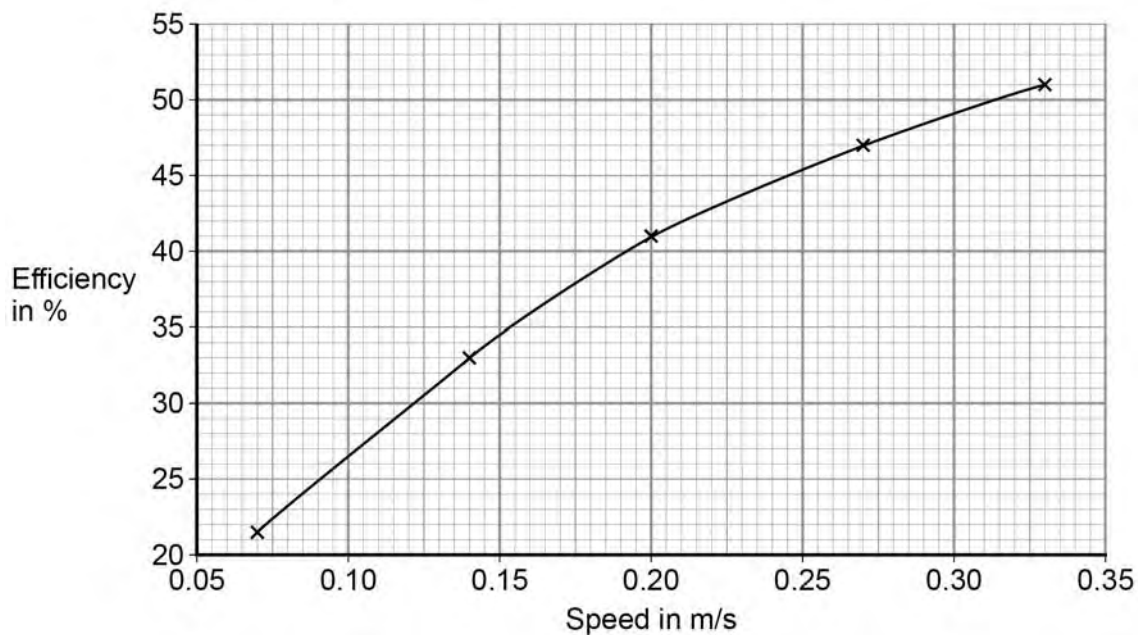

0 5 . **3** Give **two** conclusions that could be made from the data in **Figure 5**?

[2 marks]

0 5 . **4** Give the main way that the motor is likely to waste energy.

[1 mark]

0 5 . **5** When the total power input to the motor was 5 W the motor could not lift the 2.5 N weight.

State the efficiency of the motor.

[1 mark]

Efficiency = _____ %

0 6

Figure 6 shows a Van de Graaff generator that is used to investigate static electricity.

Before it is switched on, the metal dome has no net charge.

After it is switched on, the metal dome becomes positively charged.

Figure 6

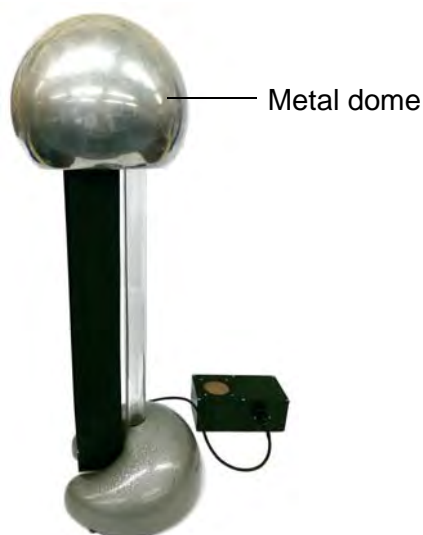
**0 6****. 1**

Explain how an uncharged object may become positively charged.

[3 marks]

0 6 . **2** **Figure 7** shows a plan view of the positively charged metal dome of a Van de Graaff generator.

Draw the electric field pattern around the metal dome when it is isolated from its surroundings.

Use arrows to show the direction of the electric field.

[2 marks]

Figure 7



Question 6 continues on the next page

0 6 . **3** Another positively charged object is placed in the electric field.

Look at **Figure 8**.

Figure 8

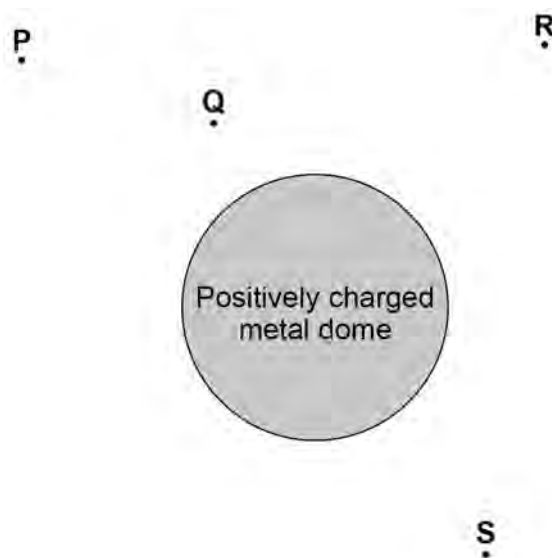

In which position would the object experience the greatest force?

Tick **one** box.

[1 mark]

- | | |
|----------|--------------------------|
| P | <input type="checkbox"/> |
| Q | <input type="checkbox"/> |
| R | <input type="checkbox"/> |
| S | <input type="checkbox"/> |

07

A student set up the electrical circuit shown in **Figure 9**.

Figure 9

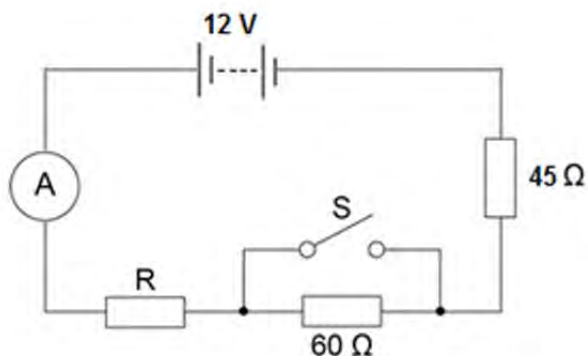

07 . 1

The ammeter displays a reading of 0.10 A.

Calculate the potential difference across the 45 Ω resistor.

[2 marks]

Potential difference = _____ V

07 . 2

Calculate the resistance of the resistor labelled R.

[3 marks]

Resistance = _____ Ω

07 . 3

State what happens to the total resistance of the circuit and the current through the circuit when switch **S** is closed.

[2 marks]

0 8

A student investigated how current varies with potential difference for two different lamps.

Her results are shown in **Figure 10**.

Figure 10

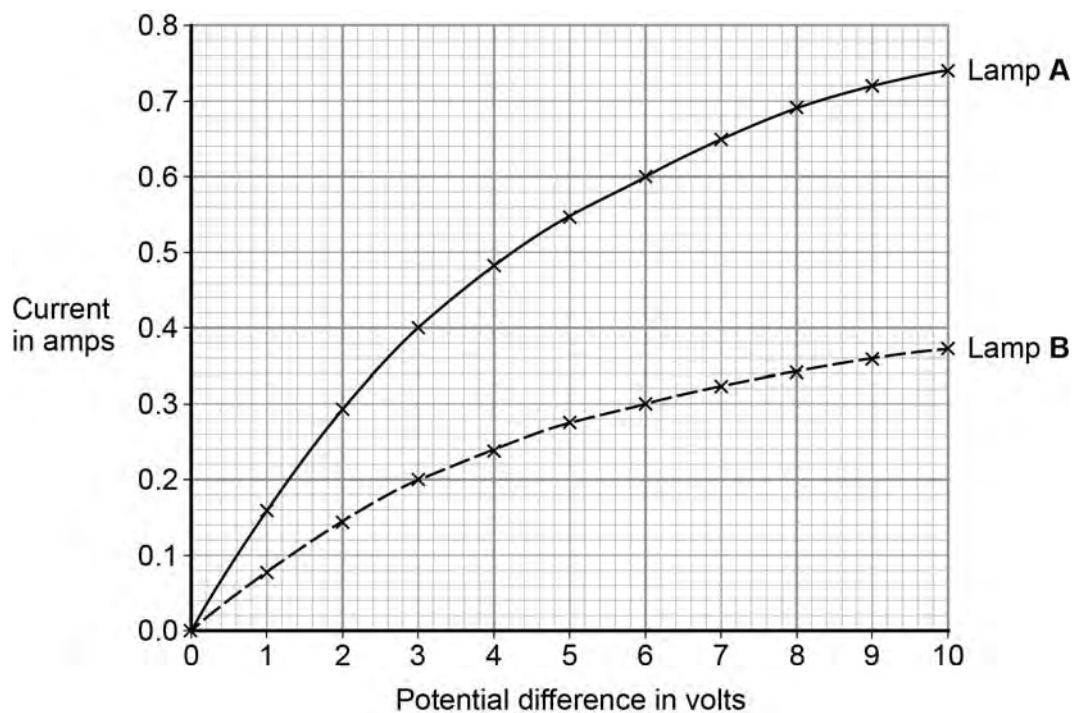

0 8 . 1

Complete the circuit diagram for the circuit that the student could have used to obtain the results shown in **Figure 10**.

[3 marks]



0 8 . **2** Which lamp will be brighter at any potential difference?

Explain your answer.

Use **Figure 10** to aid your explanation

[2 marks]

0 8 . **3** Lamp **B** has the higher resistance at any potential difference.

Explain how **Figure 10** shows this.

[2 marks]

0 8 . **4** Both lamps behave like ohmic conductors through a range of values of potential difference.

Use **Figure 10** to determine the range for these lamps.

Explain your answer.

[3 marks]

0 9

A student models the random nature of radioactive decay using 100 dice.

He rolls the dice and removes any that land with the number 6 facing upwards.

He rolls the remaining dice again.

The student repeats this process a number of times.

Table 1 shows his results.

Table 1

Roll number	Number of dice remaining
0	100
1	84
2	70
3	59
4	46
5	40
6	32
7	27
8	23

0 9 . **1**

Give **two** reasons why this is a good model for the random nature of radioactive decay.

[2 marks]

1

2

The student's results are shown in **Figure 11**.

Figure 11

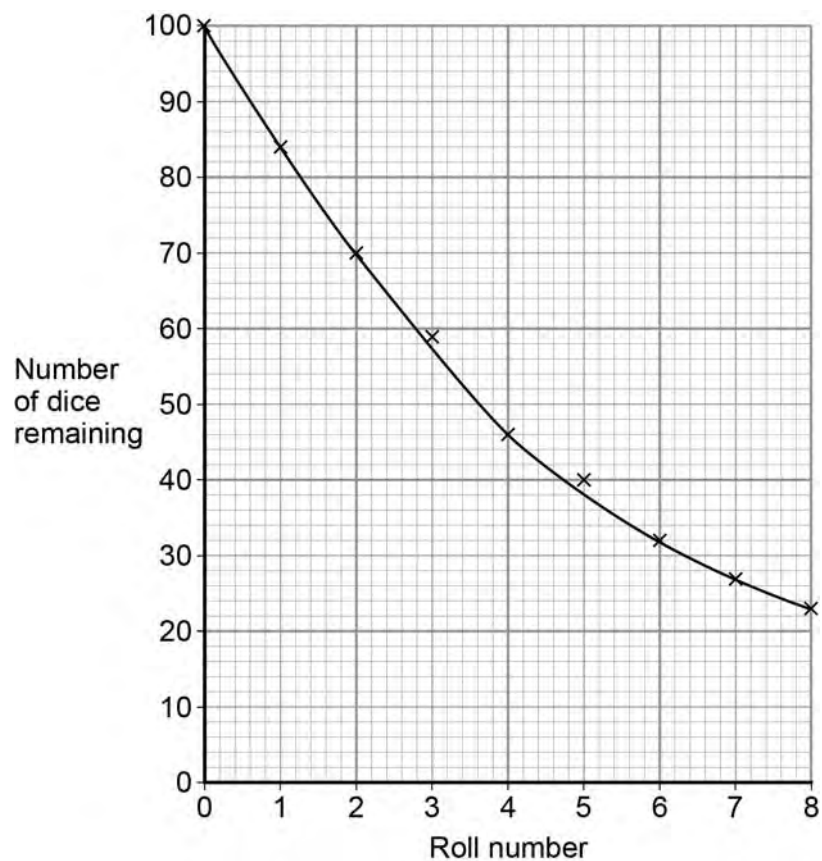

0 9 . **2** Use **Figure 11** to determine the half-life for these dice using this model.

Show on **Figure 11** how you work out your answer.

[2 marks]

Half-life = _____ rolls

Question 9 continues on the next page

A teacher uses a protactinium (Pa) generator to produce a sample of radioactive material that has a half-life of 70 seconds.

In the first stage in the protactinium generator, uranium (U) decays into thorium (Th) and alpha (α) radiation is emitted.

The decay can be represented by the equation shown in **Figure 12**.

Figure 12

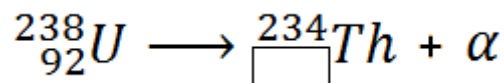

0 9 . **3** Determine the atomic number of thorium (Th) 234.

[1 mark]

Atomic number = _____

When protactinium decays, a new element is formed and radiation is emitted.

The decay can be represented by the equation shown in **Figure 13**.

Figure 13

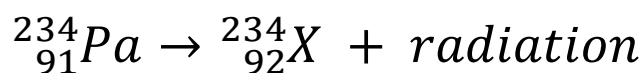

0 9 . **4** When protactinium decays, a new element, **X**, is formed.

Use information from **Figure 12** and **Figure 13** to determine the name of element **X**.

[1 mark]

0 9 . **5** Determine the type of radiation emitted as protactinium decays into a new element.

Give a reason for your answer.

[2 marks]

0 9 . **6** The teacher wears polythene gloves as a safety precaution when handling radioactive materials.

The polythene gloves do **not** stop the teacher's hands from being irradiated.

Explain why the teacher wears polythene gloves.

[2 marks]

Turn over for the next question

1	0
---	---

Electricity is generated in a nuclear power station.

Fission is the process by which energy is released in the nuclear reactor.

1	0
---	---

.	1
---	---

Figure 14 shows the first part of the nuclear fission reaction.

Complete **Figure 14** to show how the fission process starts a chain reaction.

[3 marks]

Figure 14

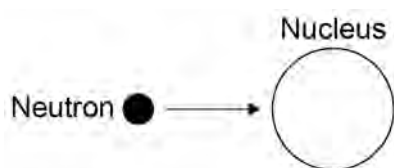
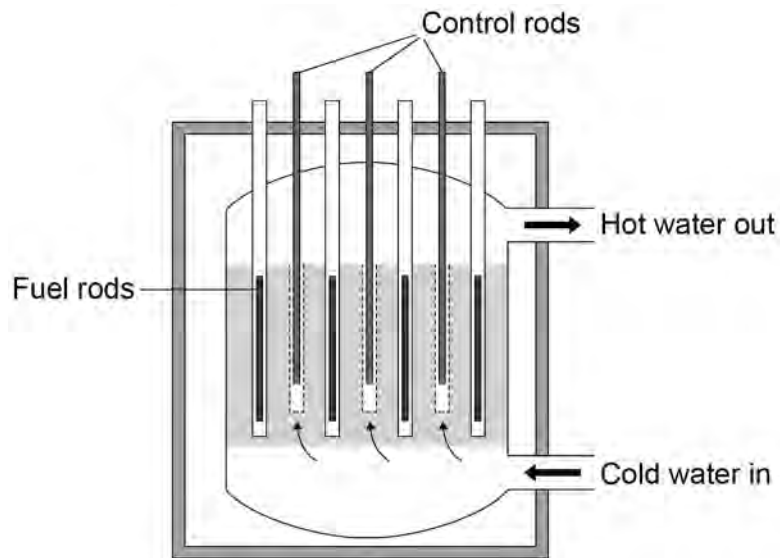

Figure 15 shows the inside of a nuclear reactor in a nuclear power station.

Figure 15



1 0 . 2 In a nuclear reactor a chain reaction occurs, which causes neutrons to be released.

The control rods absorb neutrons.

The control rods can be moved up and down.

Explain how the energy released by the chain reaction is affected by moving the control rods.

[2 marks]

Figure 16 shows how the power output of the nuclear reactor would change if the control rods were removed.

Figure 16

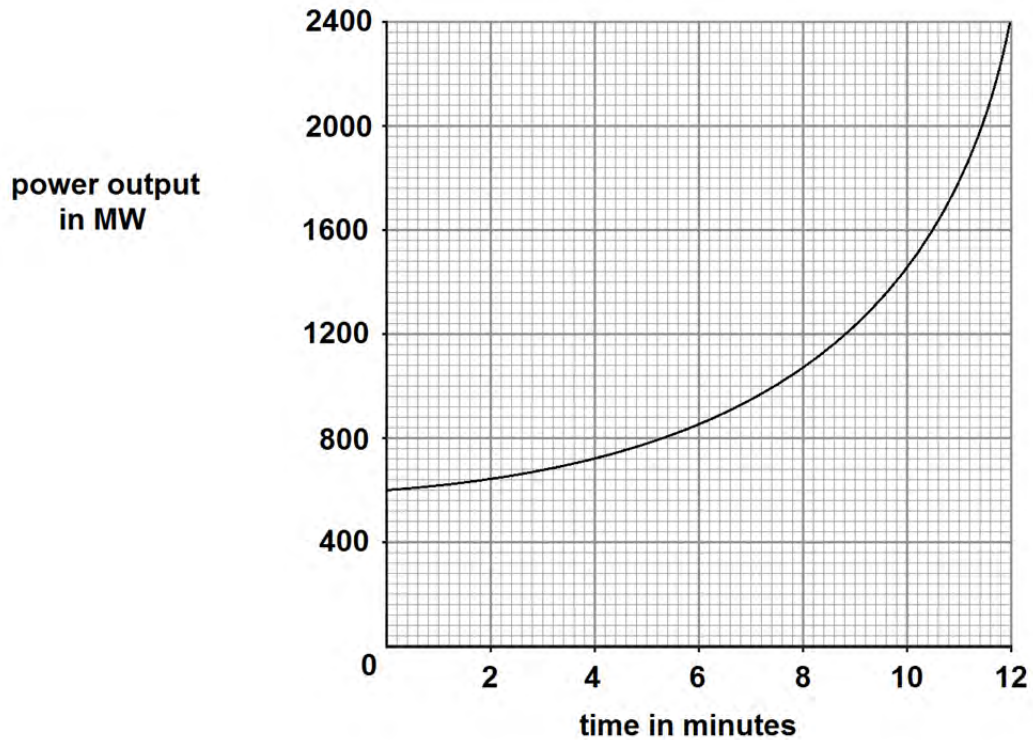

1 0 . **3** Calculate the rate of increase of power output at 10 minutes.

[2 marks]

Rate of increase of power output = _____ MW / minute

Turn over for the next question

1 1

Figure 17 shows a student before and after a bungee jump.

The bungee cord has an unstretched length of 20.0 m.

Figure 17

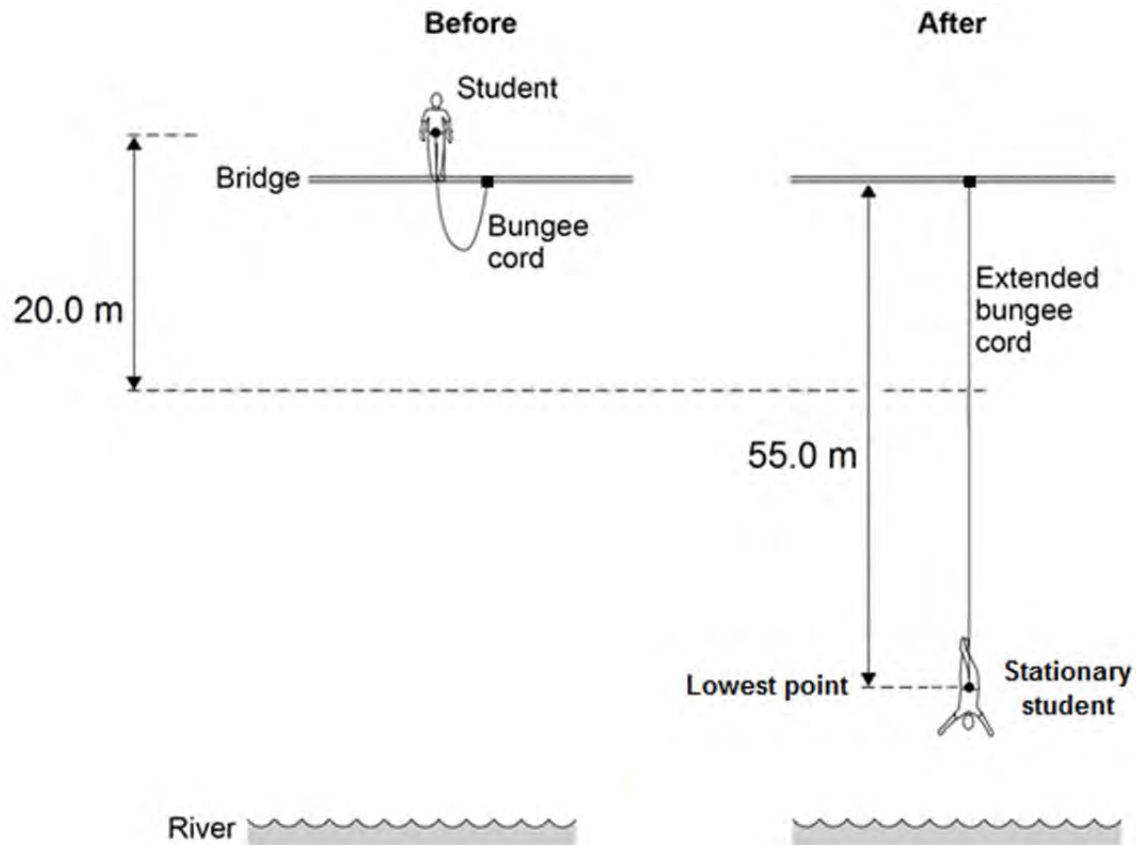

The mass of the student is 50.0 kg.

The gravitational field strength is 9.8 N/kg.

1 1 .

1

Write down the equation which links gravitational field strength, gravitational potential energy, height and mass.

[1 mark]

1 1 .

2

Calculate the change in gravitational potential energy from the position where the student jumps to the point 20.0 m below.

[2 marks]

Change in gravitational potential energy = _____ J

-
- 1 1 . 3** 80% of this change in gravitational potential energy has been transferred to the student's kinetic energy store.

How much has the student's kinetic energy store increased after falling 20.0 m?

[1 mark]

Kinetic energy gained = _____ J

- 1 1 . 4** Calculate the speed of the student after falling 20.0 m.

Give your answer to two significant figures.

[4 marks]

Speed = _____ m/s

- 1 1 . 5** At the lowest point in the jump, the energy stored by the stretched bungee cord is 24.5 kJ.

The bungee cord behaves like a spring.

Calculate the spring constant of the bungee cord.

Use the correct equation from the Physics Equation Sheet.

[3 marks]

Spring constant = _____ N / m

1 | 2

A student wants to calculate the density of the two objects shown in **Figure 18**.

Figure 18



Metal cube



Small statue

Describe the methods that the student should use to calculate the densities of the two objects.

[6 marks]

1 3

An electrician is replacing an old electric shower with a new one.

The inside of the old shower is shown in **Figure 19**.

Figure 19



1 3 . 1

If the electrician touches the live wire he will receive an electric shock.

Explain why.

[4 marks]

Different electrical wires need to have a cross-sectional area that is suitable for the power output.

Figure 20 shows the recommended maximum power input to wires of different cross-sectional areas.

Figure 20

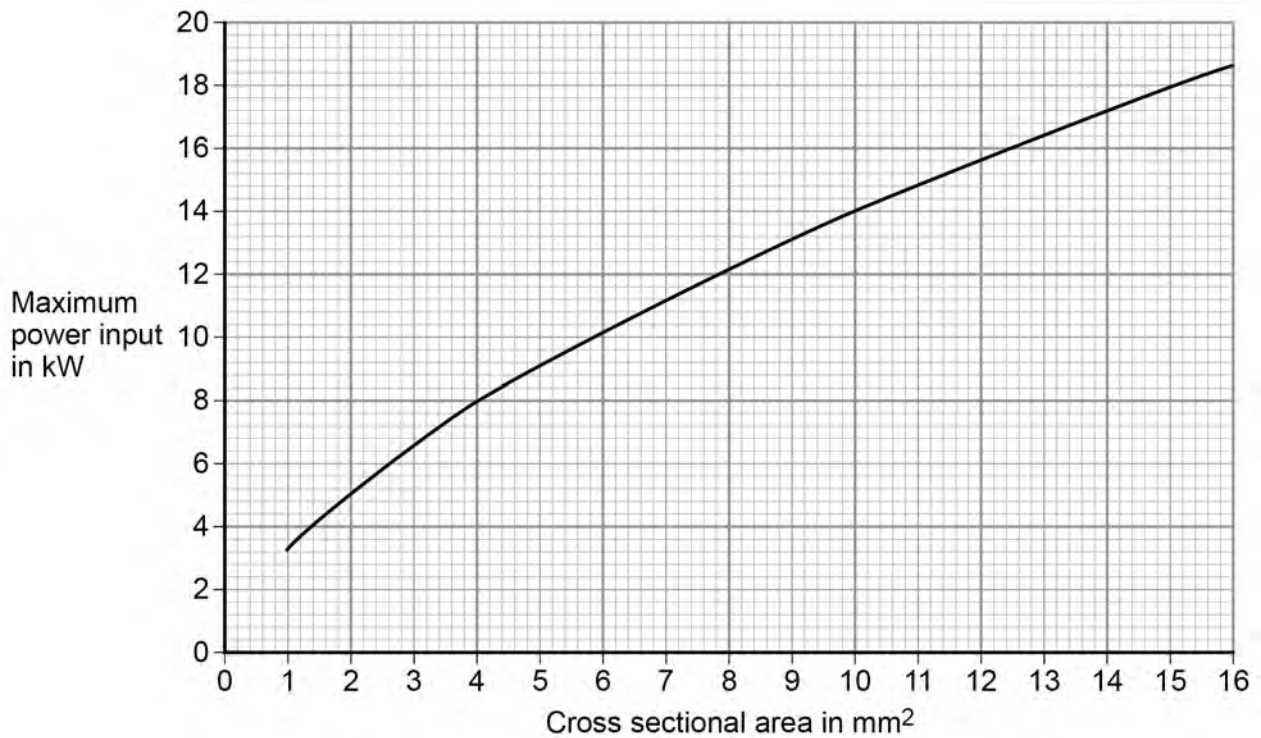

1 3 . **2** The new electric shower has a power input of 13.8 kW.

Determine the minimum **diameter** of wire that should be used for the new shower.

The diameter, d , can be calculated using the equation:

$$d = \sqrt{\frac{4A}{\pi}}$$

A is the cross-sectional area of the wire.

[2 marks]

Minimum diameter = _____ mm

-
- 1 3** . **3** The charge that flows through the new shower in 300 seconds is 18 000 C.
The new electric shower has a power of 13.8 kW.

Calculate the resistance of the heating element in the new shower.

Write down any equations you use.

[5 marks]

Resistance = _____ Ω

END OF QUESTIONS

Copyright information

Permission to reproduce all copyright material has been applied for. In some cases, efforts to contact copyright-holders may have been unsuccessful and AQA will be happy to rectify any omissions of acknowledgements in future papers if notified. If you have any queries please contact the Copyright Team, AQA, Stag Hill House, Guildford, GU2 7XJ.

Copyright © 2016 AQA and its licensors. All rights reserved.

Figure 6: Photograph © Michael Priest
Figure 18: Photograph © Thinkstock
Figure 19: Photograph © Michael Priest